

**THE COMPACT CENTRAL VACUUM SPECIALIST**

Please note the IVD-660-H is sold as one master convertible unit. If you desire to flush mount the IVD-660-H, you will need to remove the side panels and purchase the mounting frame separately (K-385)

RECORD THIS INFORMATION FOR FUTURE REFERENCES

MODEL NUMBER \_\_\_\_\_

DATE OF PURCHASE \_\_\_\_\_

PLACE OF PURCHASE \_\_\_\_\_

Manual # **M13-E**      date: 3/2017  
Rev.: 3.27.2023

**INSTALLATION and OPERATING MANUAL      120 and 220 volt**

**MODEL: IVD 660-F**  
**IN-WALL INSTALLATION**  
(Mounting frame sold separately)



**MODEL: IVD 660-H**  
**SURFACE MOUNTED**  
with side panels



**IMPORTANT:**

To extend the life of a vacuum motor, it is very important to protect the motor from the dirt you are vacuuming up.

Always attach the **dust bag** properly, and the **filter** under the bag in the correct position. See page 10.

**IF YOU SHOULD HAVE ANY QUESTIONS OR EXPERIENCE A PROBLEM WITH YOUR INTERVAC PRODUCT, DO NOT RETURN THIS PRODUCT TO THE STORE OR DEALER PLEASE CALL US DIRECT 1-888-499-1925**

**WARNING: Owner read carefully.**

This manual must be read and understood before installation, adjustment, service, or maintenance is performed. This unit should be installed by a qualified technician. Modification of this product can be extremely hazardous and could result in personal injury or property damage. Instructions must stay with unit.

**InterVac Design Corp., Palm City, FL 34990**  
2939 SW 42nd Avenue

Phone 772-463-1400 • USA & Canada toll free 888-499-1925  
www.intervacdesign.com • e-mail: sales@intervacdesign.com



## WARNING: TO REDUCE THE RISK ELECTRIC SHOCK, DO NOT USE ON WET SURFACES

1. Unplug from electrical outlet when not in use and before servicing.
2. Do not use on wet surfaces or to suck up drywall/saw dust.
3. Never operate this vacuum cleaner without a dust bag and filters in place.
4. Close attention is necessary when used by or near children. Do not allow unit to be used as a toy.
5. Use only for intended use as described in this manual. Use only the manufacturer's recommended attachments and dust bag.
6. Do not use with damaged cord or plug. If appliance is not working as it should, has been dropped, damaged, left outdoors, or fell into water, return the vacuum cleaner to InterVac or an authorized service dealer for examination and repair.
7. Do not put any object into openings. Do not use with any openings blocked; keep free of dust, lint, hair, and any other material that may reduce air flow. If the secondary filter becomes dirty, rinse in warm water or replace with a new filter. Filter should be completely dry before using.
8. Never drop or insert any object into any opening.
9. Turn off all controls before unplugging.
10. Do not pull or carry by cord, do not use cord as a handle, do not close a door on the cord, or pull cord around sharp edges or corners. Do not run over cord. Keep cord away from heated surfaces.
11. Do not unplug by pulling on cord. To unplug, grasp the plug, not the cord.
12. Keep hair, loose clothing, fingers, and all parts of body away from any openings and all moving parts.
13. Do not pick up anything that is burning or smoking, such as cigarettes, matches, or hot ashes.
14. Use extra caution when cleaning on stairs.
15. Do not handle plug or appliance with wet hands.
16. Do not pick up flammable or combustible liquids such as gasoline or use in areas where they may be present.
17. Do not place objects against the vacuum cleaner. Keep area clear.
18. Do not step on the hose or pull the hose forcibly.
19. Do not pick up large objects such as wastepaper or cloth, which may clog the hose.
20. Do not install this vacuum cleaner in an area exposed to high temperatures.
21. Install this vacuum cleaner in a dry place.
22. Do not attempt to service the vacuum cleaner. Unit is sealed and cannot be opened without damage to the unit. For service, call your local authorized service dealer, or InterVac Design's Customer Care Center.

## **SAVE THESE INSTRUCTIONS** *FOR HOUSEHOLD USE*

**Polarization Instructions for models with 120volt cord only.**

**These appliances have a polarized plug (one blade is wider than the other).** This plug will fit in a polarized outlet only one way. If the plug does not fit fully in the outlet, reverse the plug. If it still does not fit, contact a qualified electrician to install the proper outlet. Do not change the plug in any way.

**When using an electrical vacuum cleaner, basic precautions should always be followed including the following:  
Read all instructions carefully before using this vacuum cleaner.**

### **LIMITED WARRANTY**

InterVac Design Corp. will repair the power unit with new or rebuilt parts, free of charge for two (2) years in North America from the date of original purchase in the event of a defect in materials or workmanship. Warranty might vary from country to country. No cash refunds. Excluded are the following items that require normal replacement:

Disposable dust bags, filters, vacuum cleaner tools, and vacuum hoses.

This warranty is extended only to the original purchaser. A purchase receipt or other proof of date of original purchase will be required before warranty performance is rendered.

**You must return your warranty card or register on our website to be covered under these provisions.**

This warranty only covers failures due to defects in materials or workmanship which occurs during normal use and does not cover damage which occurs in shipment or failures which are caused by products not supplied by InterVac Design, or failures which result from accident, misuse, abuse, neglect, mishandling, misapplication, alteration, modification, or commercial use such as hotel, office, restaurant or rental use of the product, or service by anyone other than an authorized service center, or damage that is attributable to acts of God.

There are no expressed warranties except as listed above.

### **LIMITS AND EXCLUSIONS:**

INTERVAC DESIGN SHALL NOT BE LIABLE FOR INCIDENTAL OR CONSEQUENTIAL DAMAGES RESULTING FROM THE USE OF THIS PRODUCT OR ARISING OUT OF ANY BREACH OF THIS WARRANTY. ALL EXPRESSED AND IMPLIED WARRANTIES, INCLUDING THE WARRANTIES OF MERCHANTABILITY AND FITNESS FOR A PARTICULAR PURPOSE, ARE LIMITED TO THE APPLICABLE WARRANTY PERIOD SET FORTH ABOVE.

Some states do not allow the exclusion or limitation of incidental or consequential damages or limitations on how long an implied warranty lasts, so the above exclusions or limitations may not apply to you. This warranty gives you specific legal rights that vary from state to state. If a problem with this product develops during or after the warranty period, you may contact your dealer or our service center. If the problem is not handled to your satisfaction, then write to the Customer Service Center at the company address.

**Specification: 120 Volt, 12.5 Amp 50/60Hz, high efficiency motor, 660 air watts.**  
**220/230 Volt, 6.5 Amp 50/60 Hz 11 lb, 660 Air Watts**

**Parts List:**

**Model IVD660-F, (flush, recessed in wall)**

Mounting frame #K-385 for 2x4 wood studs, 16" on center  
6 screws for installing frame  
1 K-384, 1 K-382, 1 K-355 for connection to piping system

**MODEL IVD660-H, (hanging, surface mounted)**

Metal vacuum hanger + screws  
Left and right-side panels  
1 K-383, 1 K-357 Fittings, see page 7

**CAUTION: Connect to Individual Branch Circuit**

To avoid possible electrical shock, be sure that electricity is turned off at the main switch or circuit breaker. *All hard wiring must be in accordance with the US National Electric Code or Canadian Electric Codes.* **WARNING: Electrical connection should be made by a qualified electrician**

**interVac Model 660-H Hanging, surface mounted Installation with Power Cord attached.**

**You have 2 installation options:**

- A) Standalone vacuum, no pipes installed, use with blocked flanged fitting #K-383 and top plate #K-357, see page 7.
- B) Installation with existing or new pipe connection, use black flanged fitting #K-382, top plate with pipe hole #K-355 and special reducer #K-384.

1. To remove door from vacuum, place your hand on the curved bracket at the top of the door and pull towards you. To reinstall the door, open the valve cover, align the hole with the hole in the dust bag, then push door straight in.
2. Position and install the mounting steel bracket for the vacuum at a comfortable height on the wall and close to a 120-volt receptacle, so that the power cord may be plugged directly into the outlet.  
**DO NOT USE AN EXTENSION CORD TO CONNECT THE APPLIANCE TO THE OUTLET.**

**Option A) installation:**

3. Take the top plate K-357 and add to the top of vacuum, install the 2-side panel which hold the top plate in place. Tighten the 4 screws inside the vacuum chamber.
4. Install the blocked flanged fitting K-383 inside the vacuum chamber against the hole in the top. The pipe end will support the dust bags second opening. Secure with the four screws supplied. Take the fitting and with the O-ring side of the fitting first, insert into the hole inside the top of the vacuum chamber.
5. Hang the vacuum on to the steel mounting bracket. Be sure to keep the yellow low-voltage wires in the groove on the back of the vacuum cleaner. They are used only with remote installed vacuum valves (option B).

**Option B) installation:**

6. Generously apply a lubricant, such as Vaseline, to the O-ring on the flanged fitting K-382. Take the fitting and with the O-ring side first, insert into the hole inside the top of the vacuum chamber. Secure with the four screws supplied. (See page 7).
7. Take the top plate K-355 with the 2" hole and the K-384 special reducer. Slide the K-384 from the bottom side of the top plate into the 2" diameter hole.
8. Now add this assembly to the top of the vacuum. pull the low voltage wires through the small hole in the top plate. Please note that the K-384 reducer seals itself to the O-ring of the K-382 flanged fitting on top of the vacuum. The small hole with the low voltage wires should be at the back of the vacuum.
9. Installing the 2 side panels which also hold the top plate K-355 in place:  
You will notice 3 hooks on the upper back side of the vacuum and 1 on the bottom, on each side. The panels attach to the hooks and fold forward.  
Tighten the 4 screws in the vacuum chamber, double check that the 4 hooks are connected to panels.
10. Hang the vacuum over the mounted steel bracket.  
Be sure to keep the yellow low-voltage wires in the groove on the back of the vacuum cleaner.
11. Bring the connecting pipe from the ceiling or the wall in line with the reducer K-384.  
You need 3/4" space between the ceiling pipe and the coupling to later lift the vacuum off the metal hanger. There should be enough play in the pipe system to raise the pipe when removing the vacuum off the wall. If not use 2 elbows, 1 for the ceiling pipe and 1 for the K-384 reducer for sideways connection.
12. Install the dust bag and motor filter. Reattach the door cover.
13. Plug the cord into the outlet.
14. **Only with the utility valve cover open**, test the vacuum using the on/off switch.

interVac™

## **MODEL 660-FC, Flush mounted, power Cord** **For New Construction, In-Wall with Power Cord Attached**

**Note:** Two studs must be on 16" centers or 14-1/2" (36.8 cm) between studs.

If the studs are further apart, have the carpenter install another stud or attach only one flange to a stud and let the other side float, the vacuum will clamp it to the drywall.

The power receptacle should be in reach of the vacuums electrical cord, 5 feet long.

### **Installing the Frame in a 2 x 4 wall without drywall installed:**

1. Use the large mounting frame and slide it between the two studs. Adjust the height position so that the customer can access the vacuum comfortable. The horizontal hole in the frame should be the lower part when installed.
2. Use the supplied eight fasteners to attach the frame in place.
3. Glue the pipe reducer K-384 to your pipe coming from the ceiling.
4. Guide the pipe and reducer into the cage on top of the frame. Turn the reducer so that it cannot be pulled up.
5. Pull the low voltage wires from the pipe's installation into the center of the frame. Curl them up or tape them to a stud to prevent the dry-wall installer from cutting the wires when he removes the dry-wall from the center of the frame.

### **After drywall is installed, cut out the center of the frame:**

6. To remove the door from vacuum, place your hand on the curved bracket at the top of the door and pull toward you. You will see four screw heads in the corners with clamp-blocks outside the housing, behind the screws.
7. Find the low voltage wires inside the wall. Connect them to the yellow wires in the back of the vacuum. Be sure to keep the yellow low-voltage wires in the groove on the back of the vacuum cleaner. Clamp the wires into the two small wire holders on the top back side, to the right. This prevents the wires from falling behind the vacuum. There will only be 1/16th inch (1.5 mm) of space between the back drywall (2X4) and the back of the vacuum.
8. Hold the vacuum parallel to the frame opening and slide into the opening
9. Tighten the four screws. They will clamp around the back side of the frame.  
**DO NOT OVER TIGHTEN. DO NOT USE A POWER TOOL**
10. Generously apply a lubricant, such as Vaseline, to the O-ring on the flanged fitting, #K-382  
Take the fitting with the O-ring side up, insert into the hole inside the top of the vacuum chamber towards the pipe.  
**NOTE:** You may have to jiggle the fitting a little to center the pipe/reducer in the wall.
11. Attach the fitting with the four #8x1/2 screws.
12. Install the dust bag and motor filter. Reattach the door, by opening the utility valve cover, looking straight through the hole and aligning with the hole in the dust bag, then push door in place.
13. Plug the cord into the outlet. **Only with the utility valve cover open**, test the vacuum using the on/off switch on the lower right side. Please note that all the vacuum valves in the home are closed.

## **interVac™ MODEL 660-FR, Flush mounted, Romex cable**

**New Construction Installation. In-Wall with 14-gauge Romex Cable or use local wiring specification.**

**An electrician must install a junction box with Romex power cable from the dedicated circuit breaker about 4" below the frame and against a stud.**

Use the basic installation instruction from model FC660 (above, #1 through #7)

### **TURN OFF THE POWER SUPPLY AT THE DEDICATED CIRCUIT BREAKER.**

14. The 14 gage Romex cable extends about 18" (45 cm) from the bottom of the vacuum.
15. Carefully slide the vacuum, with the bottom part and cable first into the frame opening, pushing the cable downwards into the junction box hole.  
Now pull the bottom of the vacuum out until the cable touches the installation frame inside.  
Tilt the top part towards the frame and slide in parallel. **NOTE:** the clamps on the right side must be lifted upwards.
16. Tighten the four screws in the vacuum chamber. They will clamp around the back side of the frame.  
**DO NOT OVER TIGHTEN. DO NOT USE A POWER TOOL**
17. Generously apply a lubricant, such as Vaseline, to the O-ring on the fitting K-382. Take the fitting and with the O-ring side first and insert into the hole inside the top of the vacuum chamber towards the pipe System.  
Attach the fitting with the four #8x1/2 screws.  
**NOTE:** You may have to jiggle the fitting a little to center the reducer/pipe in the wall.
18. Install the dust bag and motor filter. Reattach the door.  
An electrician should connect the Romex wires in the junction box.
19. **Only with the utility cover open**, test the vacuum using the on/off switch on the lower right side.  
Please NOTE that all the vacuum valves in the home are closed.

**interVac** **MODEL 660-FC**, *Flush mounted with power Cord*  
**STAND-ALONE Installation into existing 2x4 Dry-Wall, no Pipe Connection**

Use 2 Plywood Strips  $3/8" \times 1-1/2" \times 22"$  long with double sticking tape.

If you do not have installation frame #K385 as a cutout template, use the dimensions in the drawing. You also need the new blocked intake fitting #K-383, see below.

- 1) Find the edge of a wall stud with a 120-volt receptacle close by.
- 2) From the edge measure  $1-1/2$  to  $1-3/4"$  into the wall cavity. The actual dimension is  $1-1/2$  but you never know if the stud is straight inside the wall.
- 3) Use a level to mark a vertical line on the edge, about the height of the vacuum.
- 4) Take the frame #K-385 and align the inside of frame with the vertical marked line, it might take 2 people.
- 5) Mark the inside of the frame for the cut-out.
- 6) Carefully cut the opening for the vacuum, the width should be  $9-1/4"$  and the height  $18-1/4"$ .
- 7) Take one of the plywood strips and attach the double sticking tape to the wood.
- 8) Carefully attach strip to the edge of the dry-wall opening --- do not push against the wall stud.
- 9) Now install the second strip to the other side of the opening, right at the dry-wall edge. The opening must be  $9-1/4"$  wide, on the bottom and top of opening.
- 10) Level and smooth out the lower dry-wall edge, the vacuum will sit on it.
- 11) Installing the K-383 fitting:  
install 2 screws first in the back of the upper vacuum chamber, a couple of turns only. Slide the fitting under the screw heads and tighten screws, now install the 2 other screws.
- 12) slide the vacuum in the opening and tighten the 4 screws in the 4 corners in vacuum chamber.

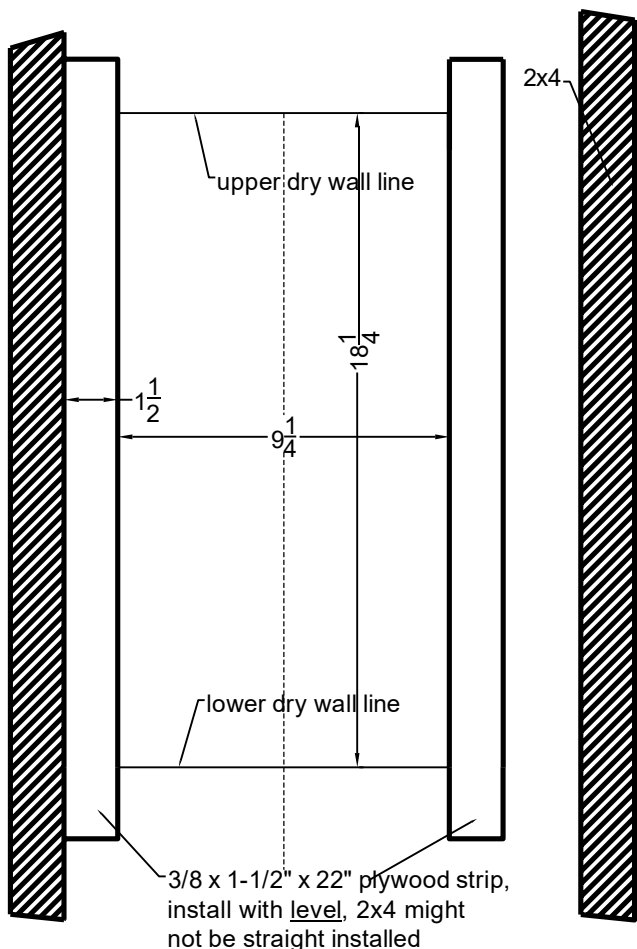

K-383 blocked intake fitting

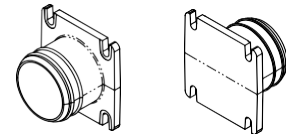

Frame between 2 studs, 16" center, with reducer, pipe and wire installed



Dry wall on top of frame with low voltage wires shown



Outside Exhaust attachment # K-365 on bottom of vacuum connecting to the hole in the mounting frame. (Not available at this time)

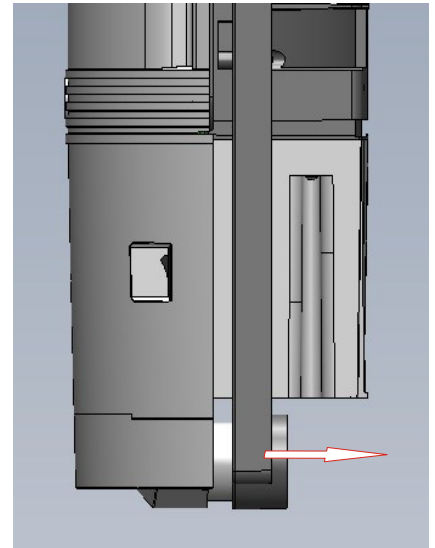

Vacuum with junction box installed



Romex cable to junction box



K-365 EXHAUST COVER

(not available at this time)

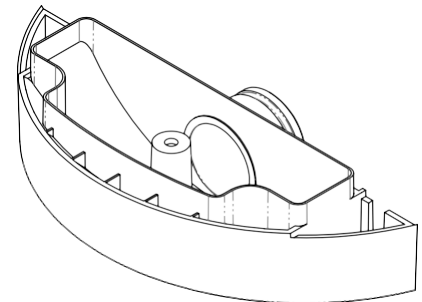

Attaching flanged fitting, #K-382 for piped system and #K-383 for stand-alone vacuum



Flexible connection between pipe, coming from ceiling, into vacuum. Model 660-H only, for lifting vacuum 1/2" up and off the mounting bracket

**BACK VIEW OF IVD660-H VACUUM**  
**Installing hanger (metal) for surface mounting**

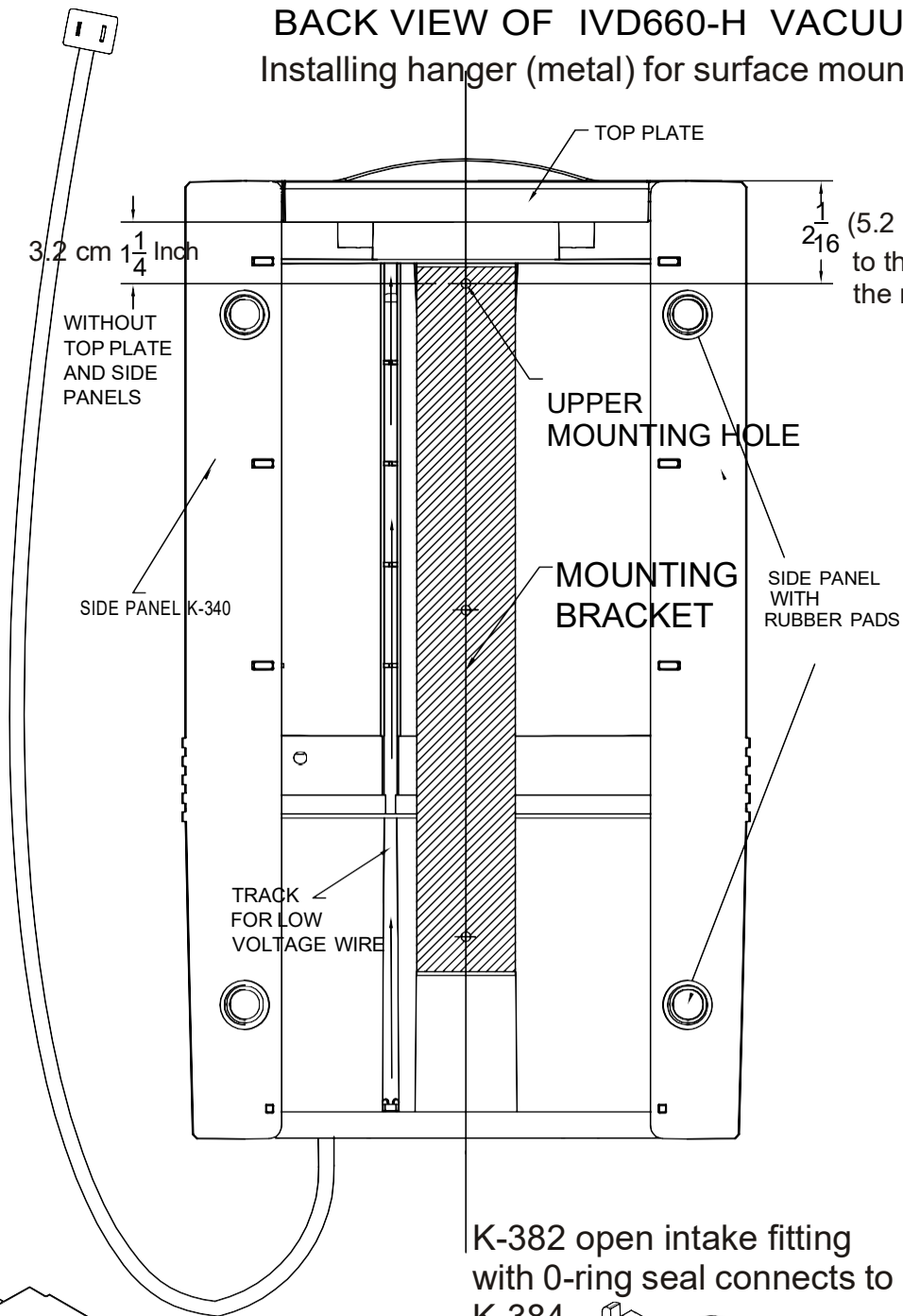

(5.2 cm) dimension to the first hole in the mounting bracket  
**Model 660-H**  
 Marking the upper mounting hole for the vacuum hanger.

K-340 side panels, left and right side are attached.  
 Remove side panels by loosening the 4 screws inside the vacuum chamber

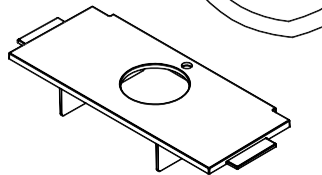

**Part # K-355**  
 Top Plate with pipe hole

K-382 open intake fitting with O-ring seal connects to K-384

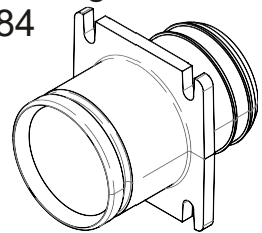

K-384 Special reducer fitting for pipe connection inside a wall

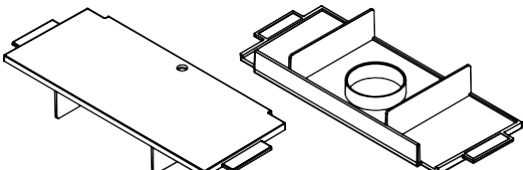

**Part # K-357** Top Plate with plug to seal off vacuum chamber, for none piped installations.

K-383 blocked intake fitting

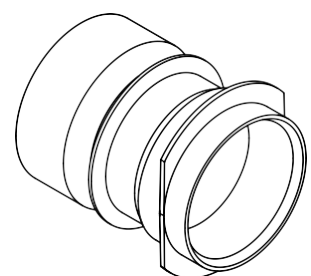
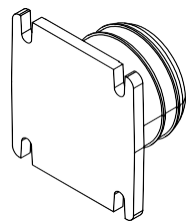

FRONT VIEW OF IVD660-H VACUUM

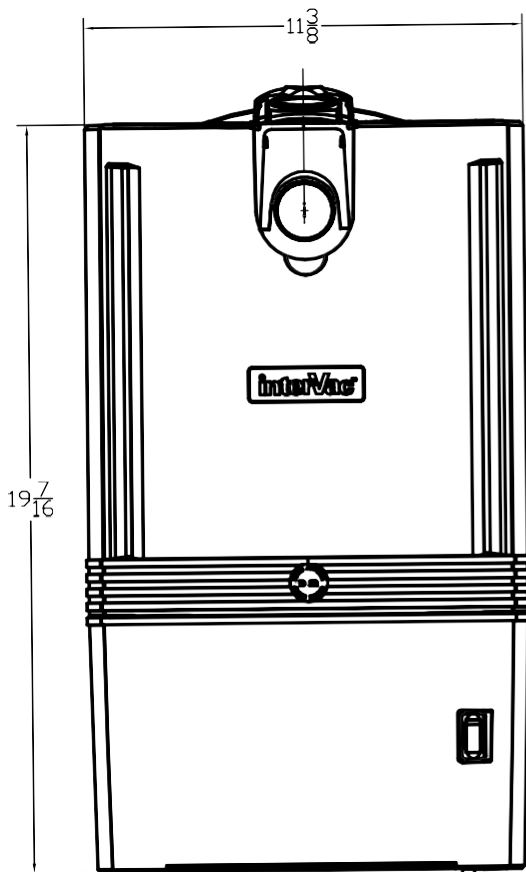

InterVac Design Corp.  
Palm City, Fl. 3-1-2017

SIDE VIEW OF IVD660- VACUUM

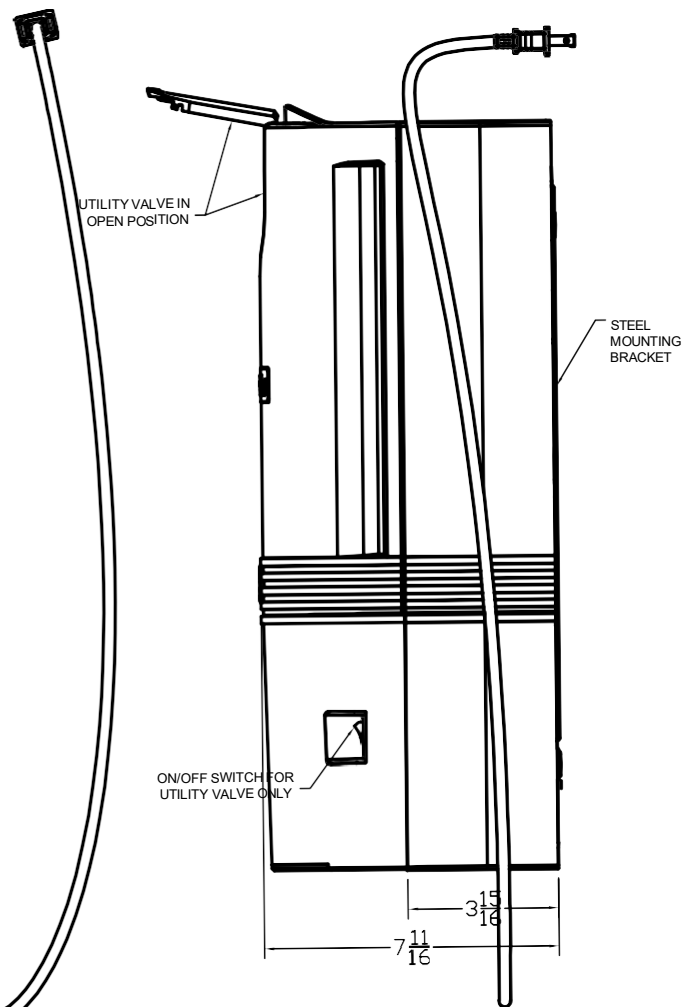

For Model 660-H  
Surface mounted installation with  
# K-395 pipe slider, if available.

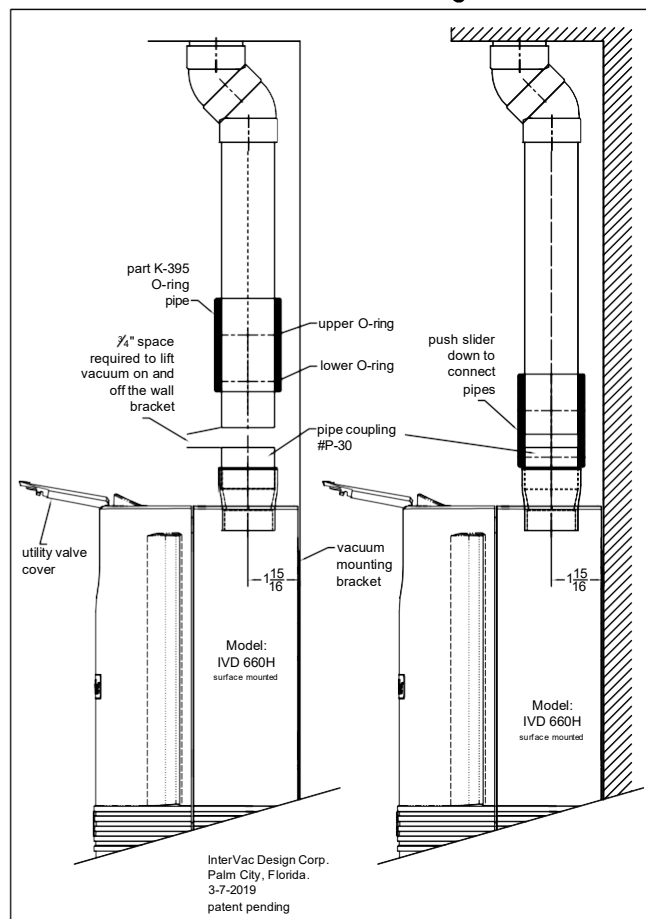

InterVac Design Corp.  
Palm City, Florida.  
3-7-2019  
patent pending



## HOW TO OPERATE YOUR MODEL: [IVD-660](#)

*This appliance is equipped with an automatic-reset thermal protector to protect the motor from overheating due to a blockage in the vacuum tools or hose. In the event the thermal protector operates due to the motor overheating, do the following. Turn off the unit and unplug it from the wall (required to reset the thermal protector). Inspect and remove any blockage. Allow the appliance to cool down, then plug the appliance back in and resume using.*

PLEASE NOTE: NORMALLY A CENTRAL VACUUM CLEANER IS STARTED WITH THE VACUUM VALVES AROUND THE HOUSE WALLS. WITH THE INTERVAC YOU CAN ALSO UTILIZE THE VALVE IN THE DOOR OF THE POWER UNIT TO CLEAN YOUR GARAGE OR CAR USING THE on/off SWITCH.

### **A: IMPORTANT:**

**DO NOT TURN SWITCH ON AT VACUUM, WITHOUT VACUUM HOSE ATTACHED OR VALVE OPEN.**

**Use On / Off Switch only with vacuum hose attached**

1. To start the vacuum cleaner, push the switch to the "I" position.
2. To stop the vacuum cleaner, push the switch to the "O" position.

### **B: Connecting and disconnecting the hose at the POWER UNIT.**

1. Lift the inlet (utility)valve cover on the front of the door.
2. Insert hose cuff with a twist and push to secure.
3. To remove, **with one hand hold the door in place**, and with the other turn hose in either direction while pulling hose towards you.

### **C: How to change the dust bag, DO NOT REUSE DUST BAG**

**Replacement bag: Part # [Y20](#) high filtration 5-layer fiber bag.**

1. Take the door off the vacuum cleaner, by pulling the arched handle on top of the door towards you.
2. Pull the front collar holder (on dust bag) out and down. See page 10, pic 6 and 7.  
Pull the top collar (white) down from the pipe and remove dust bag form the collar holder.
3. Discard full bag
4. Now slide the green front collar of a new bag into the holder all the way into the groove. See below.
5. With both hands behind the bag hold the white top collar. In an angle slide the collar onto the small ledge in the back behind the pipe. See arrow in picture 3 and 4. Lift the collar up and push up as high up as possible.
6. Now insert the collar holder with the green collar into the cavity on top, see page 10, pic 5,6 and 7
7. The last thing to do, please push the front collar up so it is in the center of the holder. Page 10, pic 8.

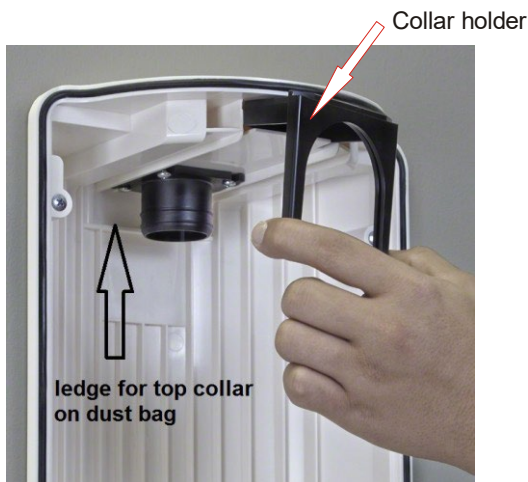

Pic. 5



Pic. 6



Pic. 7



Pic. 8



**D: To change motor filter when dirty, replacement Part # [Y25](#)**

1. Remove door and dust bag.
2. Reach into the bottom of the vacuum chamber and pull the motor filter out.

**Please, notice there is a 1/2" radius cut out on the back side of the filter towards the right.**

**The new filter must be inserted with the 1/2" cut out into the same area, see to it that the filter is all the way pushed under the vertical ribs!**

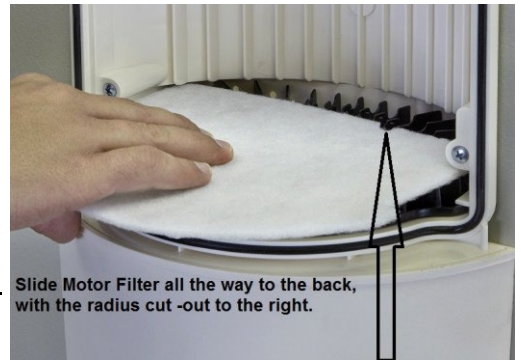

**E: Closing the Door**

1. Take the door and open the utility valve cover.
2. Lift the door parallel with the front of the vacuum. Align the hole in the door with the hole in the bag collar behind, then push door with both hands in place.
3. Before closing door, tuck in the sides of the bag, and watch that the motor filter lays flat under the dust bag so the door can properly seal.

Dust Bag # [Y-20](#)                      Motor Filter # [Y-25](#)                      Exhaust Filter # [Y-50](#)  
 Replacement Set, 3-Pack:  
 Part # [Y20-3](#), includes 3 dust bags, 1 motor filter and 3 exhaust filters

**CAUTION: DO NOT PICK UP LIQUIDS, LIT CIGARETTES, HOT ASHES, RAZOR BLADES, NEEDLES, PINS OR OTHER SHARP OBJECTS!**



[Y-20](#) dust bag

[Y-25](#) motor filter



[Y-50](#) exhaust filter



## **TROUBLE SHOOTING:**

**TIP: Model [CondoVac](#) if you do not have any suction power, but the motor runs check the following:**

- A) Is the remote Inlet Valve piping connecting the vacuum with a valve loose or properly connected?*
- B) Is the door on the vacuum is properly closed?*
- C) Is the hose door is shut all the way?*
- D) Is the dust bag full?*
- E) Has the exhaust or motor filter been replaced?*

## **NOTE: IF MOTOR SUDDENLY STOPS:**

- 1. The most common cause is a clogged hose. Disconnect vacuum hose from cleaner, hold one end high up in the air and drop a quarter or similar object into the hose. If the quarter gets stuck the hose is clogged. Try to unclog the hose with a long stick or see below "cleaning the hose".*
- 2. The bag is overfilled, or fine dust has clogged the bag. Replace with new bag.*  
**DO NOT EMPTY AND REUSE**
- 3. The vacuum cleaning tools are clogged.*
- 4. Vacuuming large amounts of dust other than household dirt, such as dry-wall or fine wood dust can block the bags pores fast, even if the bag is new; resulting in burning out the motor.*
- 5. The motor filter is dirty and should be cleaned or replaced.*
- 6. If vacuum unit is installed in an airtight compartment the exhausting air cannot escape, the motor can overheat and shut off until it has cooled down and is restarted.*

## **CLEANING THE STRETCH HOSE:**

**The stretch hose, besides all its' conveniences, tends to get clogged, especially if you have pets.**

- a) Lift the hose up on both ends and dispense some liquid detergent into both ends.*
- b) With a garden hose, holding both ends still up, fill  $\frac{3}{4}$  with water.*
- c) Shake hose up and down, let detergent loosen the dirt.*
- d) Stretch the hose as far as you can (2 people required) and wash the dirt out with the full pressure of the garden hose. Repeat if necessary.*
- e) Hang hose up, let hose drain and dry completely, up to 24 hours.*

## **MAINTENANCE INSTRUCTION:**

- a) Keep vacuum chamber clean. Use a brush to clean out dirt if accumulated.*

# interVac™ ACCESSORIES



30' Central Vacuum Hose  
PART# AS-21

**Complete Tool Kit**  
(Includes all item on the right)  
PART # TK-112



Dust Brush  
PART # [X250](#)



2 Part Upholstery  
Tool PART # [X300](#)



Telescoping Wand, PART # [X157](#)



Mesh Storage Bag, with  
Stretch Hose only  
PART # X501



Floor/Rug Tool  
PART # [X403](#)



Crevice Tool  
PART # [X200](#)

## OPTIONAL VACUUM TOOLS

35' Stretch Hose for  
quick clean up  
PART # [AS11](#)



Elongated Dust Brush  
PART # [X251](#)



Air Turbo Nozzle  
PART # X451



Dust Sweeper Inlet Valve  
"[VacPort.com](#)" for RM Models  
Model [A910](#) w/o LED light  
Model [A900](#) with LED light



INTERVAC reserves the right to make improvements and modifications without notice.

## GarageVac Models



**GF-120**  
In-wall installation where the unit fits flush into a 2x4 stud wall. Space saving. Can also be flush mounted into a garage cabinet. Minimum wall space required.



**GH-120**  
surface mounted in the hobby shop. Can easily be moved to another location. Compact and very fast access to vacuum tools and hose

## INSTALLATION POSSIBILITIES FOR GARAGEVAC



**GH-120**  
Install the vacuum close to the garage door. This way cars can be reached inside and outside the garage. Most effective installation. Minimal wall space.

## other InterVac Models



**Model RMH-120**  
Installed as a traditional central vacuum system with a vacuum valve in the living room and the power unit on the other side of the wall, it could be the garage utility room or closet.

see our website:  
[www.intervacdesign.com](http://www.intervacdesign.com)



**Model F120**  
(GF120 without the tool caddy)  
Installed in the hallway of a town house. Easiest and lowest cost of having a central vacuum in your home.

see our website:  
[www.intervacdesign.com](http://www.intervacdesign.com)

